

MOV

Metal Oxide Varistor

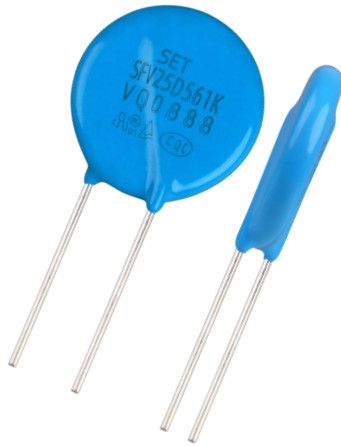

Description

Metal Oxide Varistor (MOV) as one nonlinear resistance element is mainly made of zinc oxide (ZnO), which has very high surge capacity and big nonlinear coefficient. Below the threshold voltage, its resistance is very high, nearly no current flows through, but above the threshold voltage, the resistance reduces sharply, huge current can be discharged. Due to this characteristic, varistor as a protection component in electronic and electrical equipment can absorb abnormal over-voltage and lightning surge.

SETsafe | SETfuse varistor is with High Surge Current Density, Low Clamping Voltage, and Good Surge Capacity. It can also be customized as required.

Features

- Epoxy Resin Coating
- Silicone Resin Coating
- Low Leakage Current
- Bidirectional and Symmetrical V/I Characteristics
- RoHS & REACH Compliant
- Operating Temperature Range
Low Temperature: -40 °C
High Temperature: +85 °C / +105 °C

Applications

- Power Supplies
- Home Electrical Appliances
- Industrial Devices
- Surge Protectors
- Telecom Devices

Product Structure

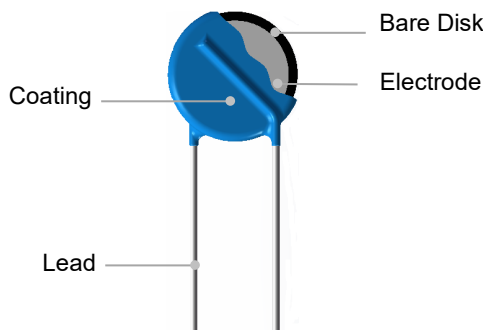

Lead Types

Lead Types		Codes
	Straight Lead	A
	Inward Crimp Lead	B
	Outward Crimp Lead	C
	Inline Crimp Lead	D
	Little Straight Lead	I

Agency Approvals

Agency	Standards	No.
	UL 1449 4 th Edition	E322662
	CSA C22.2 NO.269.5-17	E322662
	EN 61051-1:2008 IEC 61051-1:2007 IEC 61051-2:1991 IEC 61051-2-2:1991 Annex Q of IEC 60950-1:2005+A1:2009+A1:2013	J 50456266
	GB/T 10193-1997 GB/T 10194-1997 GB 4943.1-2011 GB 8898-2011	CQC21001292477

Marking

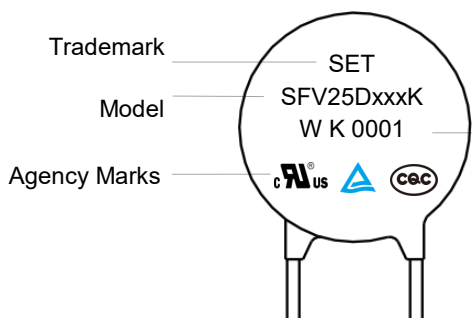

Internal code	
Year Code	2000—A
 2022—W
Surge Level	S: Normal Type K: Standard Type H: High Energy Type Q: Advanced Type
Serial No.	(E.G.: 0001)

MOV

MOV

Temp. Derating Curve

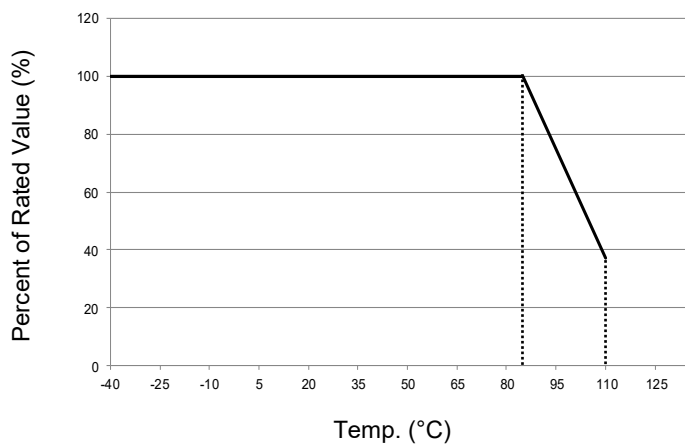

For Normal Temp. Series

Note:

When ambient Temp. exceeds 85 °C, the peak surge current and energy rating should be reduced as shown in the left curve.

General Technical Data

Item	Value	Unit
Operating Temperature	-40 to +85	°C
Storage Temperature	-40 to +125	°C
Voltage Proof	≥2500	V _{ac}
Insulation Resistance	≥100	MΩ

Part Numbering System

SFV 25 D 471 - K T K A BUL - 001

MOV

MOV

Other Options

***Packaging & Lead Length**

BUL: Bulk + Standard Lead Length (Normal L26)
 C35: Bulk + Cut to 3.5 mm
 (Range:2.5 mm to 6 mm)
 L30: Bulk + Special Lead Length 30 mm
 (28 mm to 32 mm)
 (0/1)AB: Taping + Box (Hole Pitch 12.7 mm)
 (0/1)EB: Taping + Box (Hole Pitch 15.0 mm)
 (0/1)AR: Taping + Reel (Hole Pitch 12.7 mm)
 (0/1)ER: Taping + Reel (Hole Pitch 15.0 mm)
 Note:0/1 Means Product Position
 0: In Middle of Two Holes; 1: Across the Hole

Lead Types

A: Straight Lead
 B: Inward Crimp Lead
 C: Outward Crimp Lead
 D: Inline Crimp Lead
 I : Little Straight Lead

Surge Level

K: Standard Type

Operating Temp.

N: Epoxy Coating 85 °C

Voltage Tolerance

K: ±10%
 J: ±5%
 S: Special Tolerance

Nominal Varistor Voltage

220: $22 \times 10^0 = 22 \text{ V}$
 471: $47 \times 10^1 = 470 \text{ V}$
 122: $12 \times 10^2 = 1200 \text{ V}$

Disk Shape

D: Round

Bare Disk Dimension

25: 25 mm

Product Category

SETfuse Varistor

*For more details refer to packaging information.

Glossary

Item	Description
V_N	Nominal Varistor Voltage Voltage, at specified D.C. current used as a reference point in the component characteristics.
I_L	Leakage Current Measuring at 75% of varistor voltage.
UCT	Upper Category Temp. Max. ambient temp. for which a varistor has been designed to operate continuously.
LCT	Lower Category Temp. Minimum ambient temp. at which a varistor has been designed to operate continuously.
Max. Peak Current	Max. Peak Current Max. current per pulse, which may be passed by a varistor at an ambient temp. of 25 °C, for a given number of pulses.
V_C	Clamping Voltage Peak voltage developed across the varistor terminations under standard atmospheric conditions, when passing an 8/20 μ s class current pulse.
Voltage Proof	Voltage Proof Max. peak voltage, which may be applied under continuous operating conditions between the varistor terminations and any conducting mounting surface (Applicable only to insulated varistors).
C_V	Capacitance Capacitance across the MOV measured at a specified frequency and voltage.
V_{ac}	Max. Continuous a.c. Voltage Max. a.c. r.m.s. voltage of a substantially sinusoidal waveform (less than 5% total harmonic distortion) which can be applied to the component under continuous operating conditions at 25 °C.
V_{dc}	Max. Continuous d.c. Voltage Max. d.c. voltage (with less than 5% ripple) which can be applied to the component under continuous operating conditions at an ambient temp. of 25 °C.

MOV
Metal Oxide Varistor

Dimensions (mm)

Model	L (Min.)	H (Max.)	T (Max.)	D (Max.)	d	F	F ₁	A (Max.)
SFV25D220K	20	32	5.5	28	1.20±0.05	10.0±0.6	1.3 - 2.9	35
SFV25D270K	20	32	5.8	28	1.20±0.05	10.0±0.6	1.4 - 3.1	35
SFV25D330K	20	32	6.1	28	1.20±0.05	10.0±0.6	1.5 - 3.3	35
SFV25D390K	20	32	6.4	28	1.20±0.05	10.0±0.6	1.6 - 3.5	35
SFV25D470K	20	32	5.6	28	1.20±0.05	10.0±0.6	1.4 - 3.1	35
SFV25D560K	20	32	5.8	28	1.20±0.05	10.0±0.6	1.5 - 3.3	35
SFV25D680K	20	32	6.1	28	1.20±0.05	10.0±0.6	1.6 - 3.6	35
SFV25D820K	20	32	5.4	28	1.20±0.05	10.0±0.6	1.4 - 3.0	35
SFV25D101K	20	32	5.6	28	1.20±0.05	10.0±0.6	1.5 - 3.2	35
SFV25D121K	20	32	5.8	28	1.20±0.05	10.0±0.6	1.6 - 3.4	35
SFV25D151K	20	32	6.1	28	1.20±0.05	10.0±0.6	1.7 - 3.7	35
SFV25D181K	20	32	5.4	28	1.20±0.05	10.0±0.6	1.4 - 3.3	35
SFV25D201K	20	32	5.5	28	1.20±0.05	10.0±0.6	1.5 - 3.4	35
SFV25D221K	20	32	5.6	28	1.20±0.05	10.0±0.6	1.6 - 3.5	35
SFV25D241K	20	32	5.7	28	1.20±0.05	10.0±0.6	1.7 - 3.6	35
SFV25D271K	20	32	5.9	28	1.20±0.05	10.0±0.6	1.8 - 3.8	35
SFV25D301K	20	32	6.1	28	1.20±0.05	10.0±0.6	2.0 - 4.0	35
SFV25D331K	20	32	6.3	28	1.20±0.05	10.0±0.6	2.1 - 4.1	35
SFV25D361K	20	32	6.5	28	1.20±0.05	10.0±0.6	2.3 - 4.3	35
SFV25D391K	20	32	6.7	28	1.20±0.05	10.0±0.6	2.5 - 4.5	35
SFV25D431K	20	32	6.9	28	1.20±0.05	10.0±0.6	2.7 - 4.7	35
SFV25D471K	20	32	7.2	28	1.20±0.05	10.0±0.6	3.0 - 5.0	35
SFV25D511K	20	32	7.4	28	1.20±0.05	10.0±0.6	3.2 - 5.2	35
SFV25D561K	20	32	7.7	28	1.20±0.05	10.0±0.6	3.5 - 5.5	35
SFV25D621K	20	32	8.1	28	1.20±0.05	10.0±0.6	3.8 - 5.8	35
SFV25D681K	20	32	8.5	28	1.20±0.05	10.0±0.6	4.2 - 6.2	35
SFV25D751K	20	32	8.9	28	1.20±0.05	10.0±0.6	4.6 - 6.6	35
SFV25D821K	20	32	9.4	28	1.20±0.05	10.0±0.6	5.0 - 7.0	35
SFV25D911K	20	32	9.9	28	1.20±0.05	10.0±0.6	5.6 - 7.6	35
SFV25D102K	20	32	10.5	28	1.20±0.05	10.0±0.6	6.1 - 8.1	35
SFV25D112K	20	32	11.1	28	1.20±0.05	10.0±0.6	6.7 - 8.7	35
SFV25D122K	20	32	11.7	28	1.20±0.05	10.0±0.6	7.3 - 9.3	35

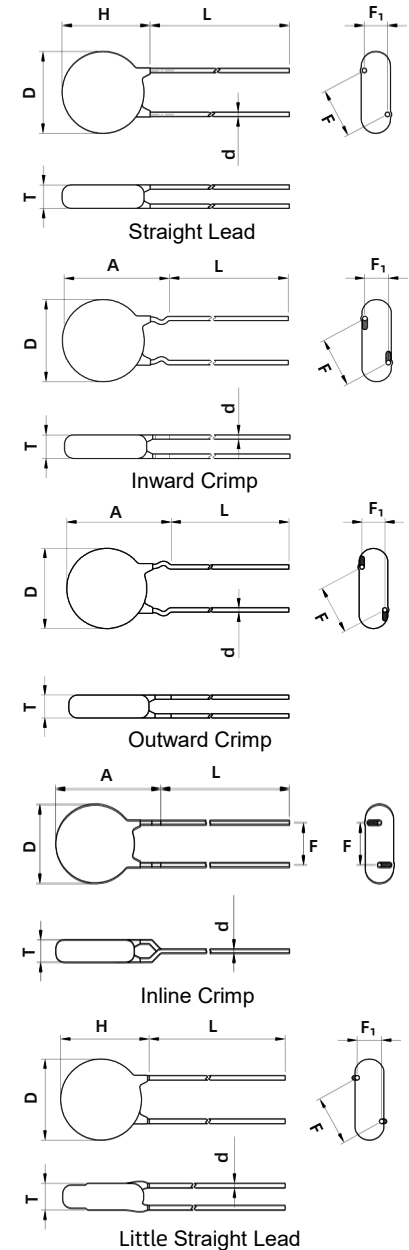

Note:
The above data is for reference only.

MOV

MOV

Specification

Model	Max. Continuous Operating Voltage		Varistor Voltage @1 mA DC		Clamping Voltage (Max.)		Max. Discharge Current (8/20 μs)		Max. Energy (10/1000 μs)	Typical Capacitance (For reference only) @1 kHz	Agency Approvals			
	Vac	Vdc	Min.	Max.	V _C	I _P	I _n	I _{max}			UL	cUL	TUV	CQC
	(V)	(V)	(V)	(V)	(V)	(A)	(kA)	(kA)	(J)	(pF)				
SFV25D220K	14	18	20	24	43	30	1.5	3	25	20500	●	●	○	○
SFV25D270K	17	22	24	31	53	30	1.5	3	30	26500	●	●	○	○
SFV25D330K	20	26	30	36	65	30	1.5	3	35	18000	●	●	○	○
SFV25D390K	25	31	35	43	77	30	1.5	3	40	13500	●	●	○	○
SFV25D470K	30	38	42	52	93	30	3	6	50	11500	●	●	●	●
SFV25D560K	35	45	50	62	110	30	3	6	60	10500	●	●	●	●
SFV25D680K	40	56	61	75	135	30	3	6	70	9050	●	●	●	●
SFV25D820K	50	65	74	90	135	150	10	20	80	7700	●	●	●	●
SFV25D101K	60	85	90	110	165	150	10	20	100	6300	●	●	●	●
SFV25D121K	75	100	108	132	200	150	10	20	120	5200	●	●	●	●
SFV25D151K	95	125	135	165	250	150	10	20	160	4300	●	●	●	●
SFV25D181K	115	150	162	198	300	150	10	20	175	3500	●	●	●	●
SFV25D201K	130	170	180	220	340	150	10	20	190	3200	●	●	●	●
SFV25D221K	140	180	198	242	360	150	10	20	200	2900	●	●	●	●
SFV25D241K	150	200	216	264	395	150	10	20	220	2650	●	●	●	●
SFV25D271K	175	225	243	297	455	150	10	20	255	2400	●	●	●	●
SFV25D301K	190	250	270	330	500	150	10	20	275	2100	●	●	●	●
SFV25D331K	210	275	297	363	550	150	10	20	300	1900	●	●	●	●
SFV25D361K	230	300	324	396	595	150	10	20	330	1750	●	●	●	●
SFV25D391K	250	320	351	429	650	150	10	20	360	1600	●	●	●	●
SFV25D431K	275	350	387	473	710	150	10	20	380	1500	●	●	●	●
SFV25D471K	300	385	423	517	775	150	10	20	400	1400	●	●	●	●
SFV25D511K	320	415	459	561	845	150	10	20	420	1250	●	●	●	●
SFV25D561K	350	460	504	616	925	150	10	20	440	1150	●	●	●	●
SFV25D621K	385	505	558	682	1025	150	10	20	450	1050	●	●	●	●
SFV25D681K	420	560	612	748	1120	150	10	20	460	950	●	●	●	●
SFV25D751K	460	615	675	825	1240	150	10	20	510	850	●	●	●	●
SFV25D821K	510	670	738	902	1355	150	10	20	520	830	●	●	●	●
SFV25D911K	550	745	819	1001	1500	150	10	20	620	730	●	●	●	●
SFV25D102K	625	825	900	1100	1650	150	10	20	690	660	●	●	●	●
SFV25D112K	680	895	990	1210	1815	150	10	20	760	600	●	●	●	●
SFV25D122K	750	990	1080	1320	1980	150	10	20	820	530	●	●	●	●

●: Approved ○: No application for certification

Performance Curve (For reference only)

- Max. Peak Current Derating Curves

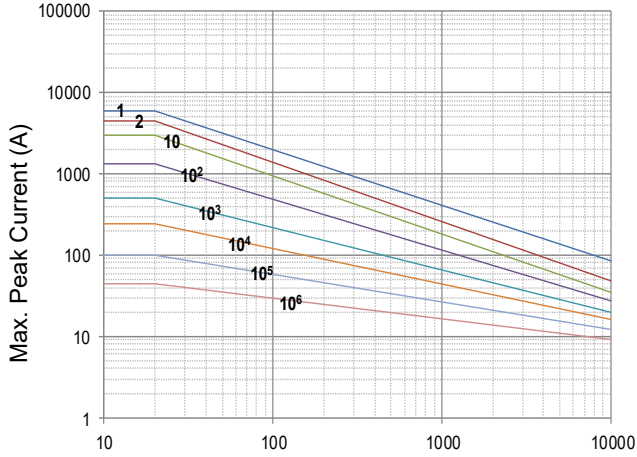

Impulse Duration (μs)
SFV25D220K to SFV25D680K

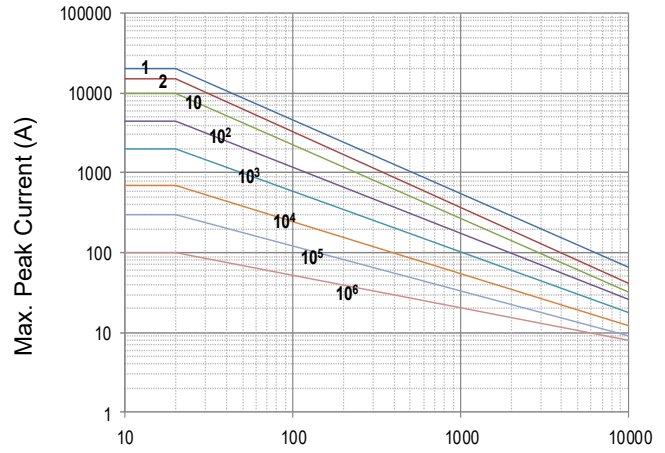

Impulse Duration (μs)
SFV25D820K to SFV25D122K

Note: 1, 2, 10, 10², 10³, 10⁴, 10⁵, 10⁶ Stand for Repetitions.

- Voltage-Current Characteristic Curves

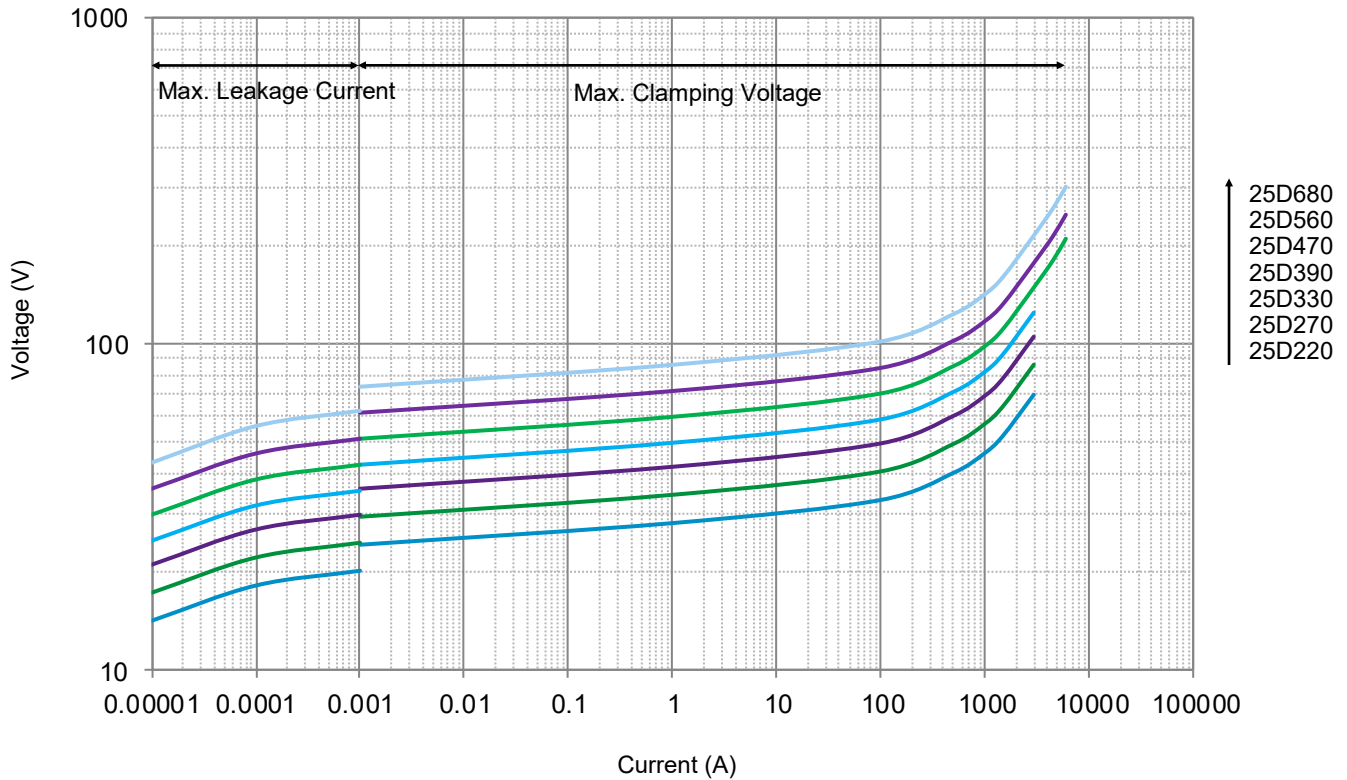

• Voltage-Current Characteristic Curves

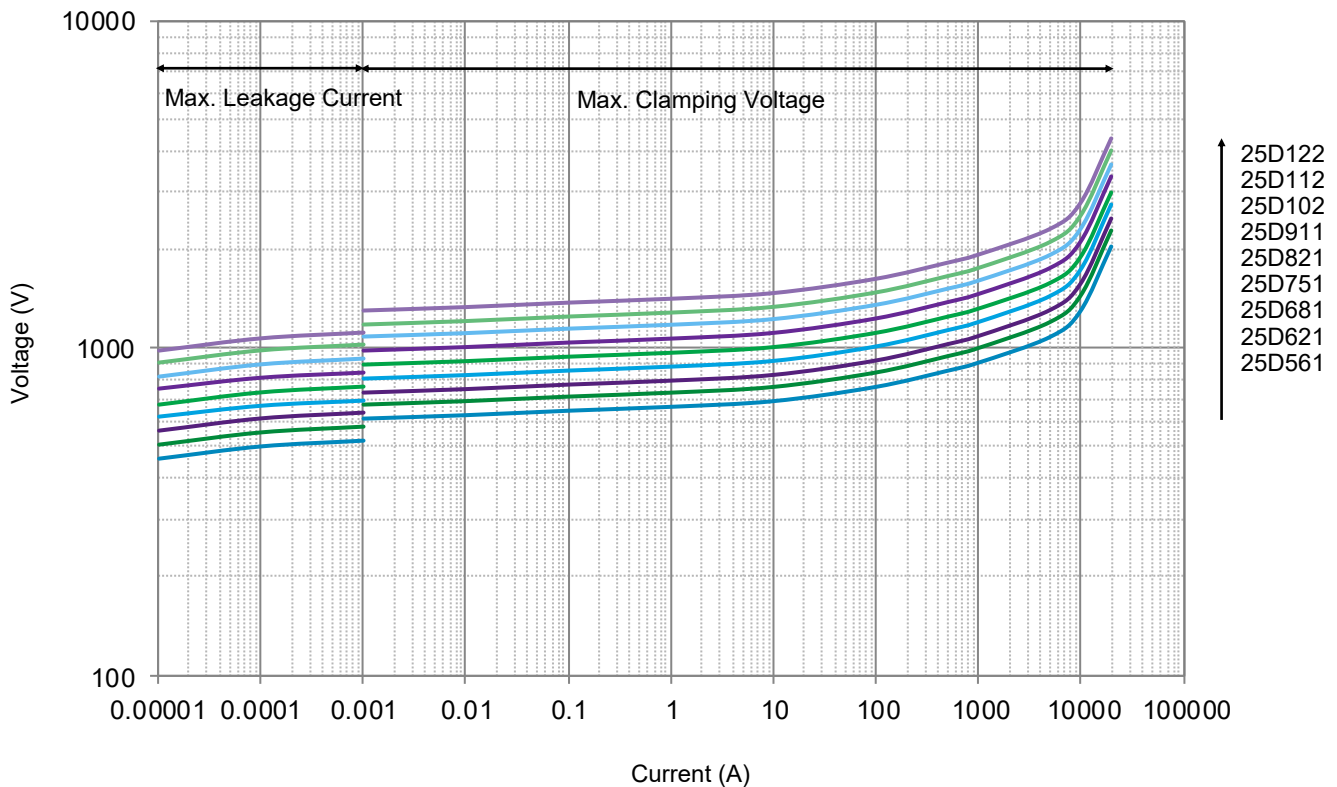
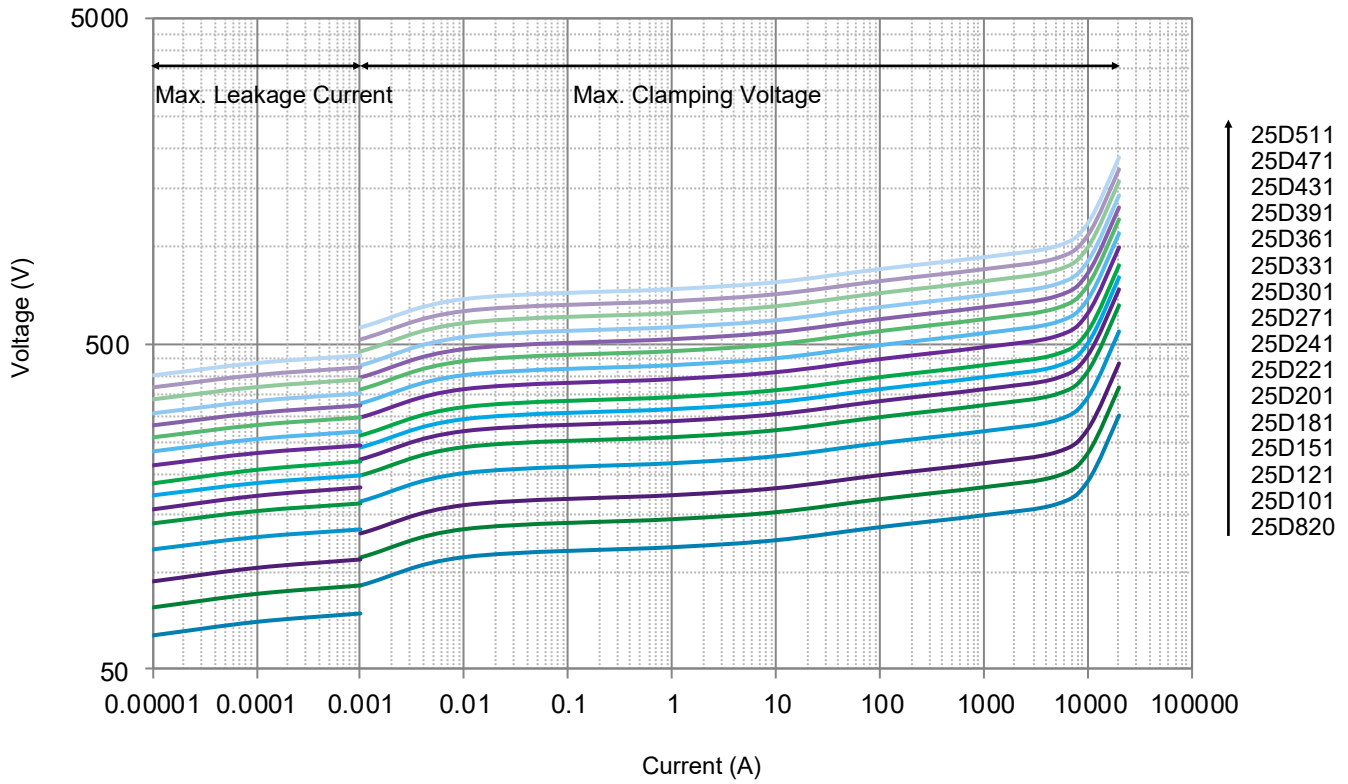

MOV

MOV

Soldering Parameters

Wave Soldering Parameters

The wave soldering parameters are for reference only. When MOV is for practice use, some related validation is recommended.

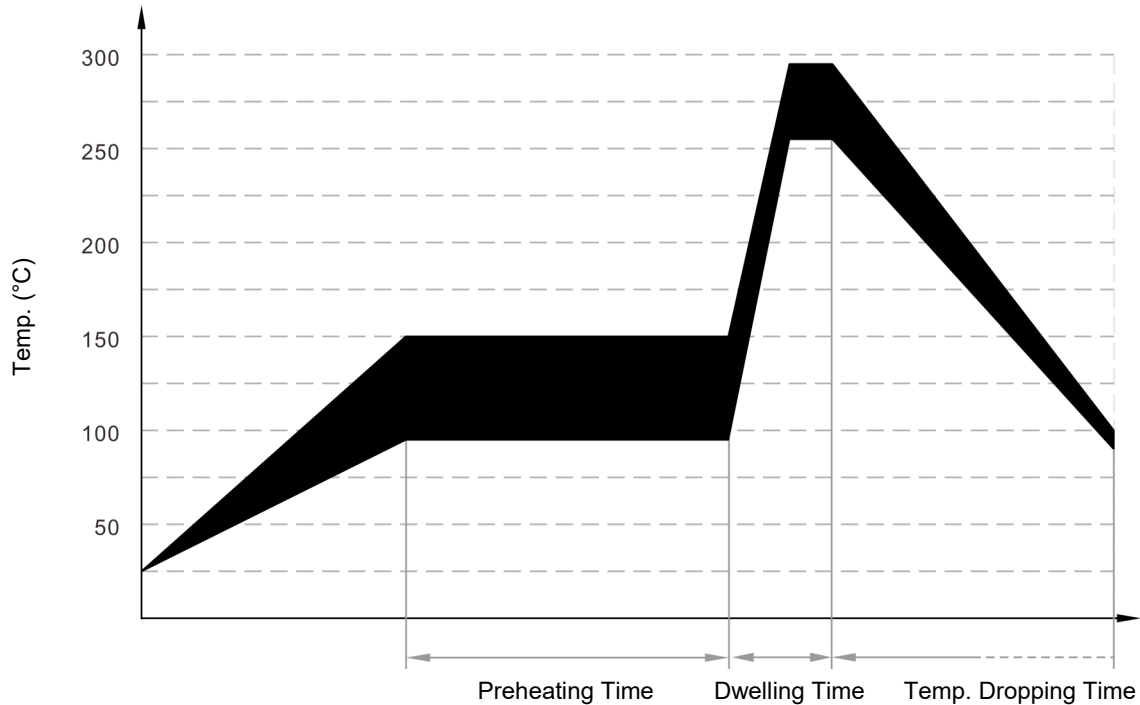

Wave Soldering Curve

Item	Temp. (°C)	Time (s)
Preheating	90 to 150	<150
Dwelling	255 to 290	3 to 10

Recommended Hand-Soldering Parameters

Item	Condition
Temp. of Solder Head	350 °C (max.)
Soldering Time	4 seconds (max.)

Packaging Information

- Bulk Packaging (Code: BUL)
- Bulk Packaging Quantity & Weight.

Series	Nominal Varistor Voltage	PE Bag	Box	Carton	G. W / Carton (365 × 265 × 245)
	(V)	(PCS)	(PCS)	(PCS)	(kg)±10%
25D	220 - 621	100	200	1200	5 - 15
	681 - 122	80	160	960	13 - 21

Note:
Other lead length packaging information, please contact SETsafe | SETfuse.

All Dimensions in mm

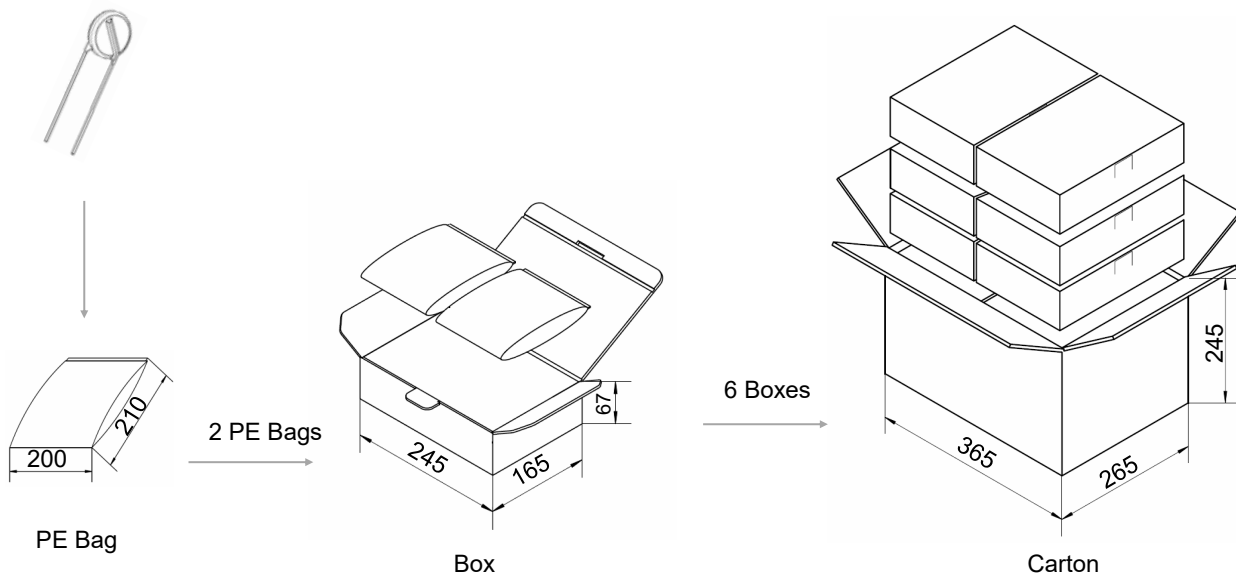



ATTENTION

Usage

1. Varistor must operated in the specified ambient temp.
2. Do not clean the varistor with strong polar solvent such as ketone, esters, benzene and halogenated hydrocarbon.
3. Please do not apply severe vibration, shock or pressure to MOV.
4. Please fix lead wires when bending or cutting. The distance between the bending point and the sealing of MOV shall be greater than 2 mm.

Replacement

If varistor is visually damaged, please replace it.

Storage

1. Storage Temp. Range: (-40 to +125) °C
2. Relative Humidity : ≤75% RH
3. Height Above Sea Level : < 2000 m

Do not store the MOV at the high temp., high humidity or corrosive gas environment, to avoid influencing the solder-ability of the lead wires, the product shall be used up within 1 year after receiving the goods.

Environmental Conditions

1. Varistor should neither be exposed to the open air, nor direct sunshine.
2. Varistor should avoid rain, water vapor or other condition of high temp. and high humidity.
3. Varistor should avoid sand dust, salt spray, or other harmful gases.

MOV

Metal Oxide Varistor

SFV25D Series

Max. Typical Capacitance of Varistor

The typical capacitance of varistor is listed in the specifications. Designers may refer to it when designing MOV in high frequency circuit.

Installation

Mechanical Stress

Do not knock MOV when installing, to avoid mechanical damage.